



Federal Bureau of Investigation

Washington, D.C. 20535

January 25, 2011

MR. JESSE C. TRENTADUE
SUITE 200
8 EAST BROADWAY
SALT LAKE CITY, UT 84111

Subject: OKBOMB ITEMS SEIZED FROM TERRY
NICHOLS' HOME ON OR ABOUT APRIL 1, 2005
FOIPA No. 1140562- 000

Dear Mr. Trentadue:

The enclosed documents were reviewed under the Freedom of Information/Privacy Acts (FOIPA), Title 5, United States Code, Section 552/552a. Deletions have been made to protect information which is exempt from disclosure, with the appropriate exemptions noted on the page next to the excision. In addition, a deleted page information sheet was inserted in the file to indicate where pages were withheld entirely. The exemptions used to withhold information are marked below and explained on the enclosed Form OPCA-16a:

Section 552

Section 552a

- Exemption selection grid including (b)(1), (b)(2), (b)(3) Rule 6(e) Federal Rules of Criminal Procedure, (b)(4), (b)(5), (b)(6), (b)(7)(A-F), (b)(8), (b)(9), (d)(5), (j)(2), (k)(1-7).

1,034 pages were reviewed and 519 pages are being released.

- Documents were located which originated with, or contained information concerning other Government agencies [OGA]. This information has been:
- referred to the OGA for review and direct response to you.
- referred to the OGA for consultation. The FBI will correspond with you regarding this information when the consultation is finished.

You have the right to appeal any denials in this release. Appeals should be directed in writing to the Director, Office of Information Policy, U.S. Department of Justice, 1425 New York Ave., NW, Suite 11050, Washington, D.C. 20530-0001. Your appeal must be received by OIP within sixty (60) days from the date of this letter in order to be considered timely. The envelope and the letter should be clearly marked "Freedom of Information Appeal." Please cite the FOIPA Number assigned to your request so that it may be easily identified.

The enclosed material is from the main investigative file(s) in which the subject(s) of your request was the focus of the investigation. Our search located additional references, in files relating to other individuals, or matters, which may or may not be about your subject(s). Our experience has shown,

when ident, references usually contain information similar to the information processed in the main file(s). Because of our significant backlog, we have given priority to processing only the main investigative file(s). If you want the references, you must submit a separate request for them in writing, and they will be reviewed at a later date, as time and resources permit.

See additional information which follows.

Sincerely yours,



David M. Hardy
Section Chief
Record/Information
Dissemination Section
Records Management Division

Enclosure(s)

The enclosed documents contained in serials 11074-11152 of 174A-OC-56120; serial 301 of 174A-OC-56120-1A; serials 557-561 of 174A-OC-56120-AA; serial 318 of 174A-OC-56120-AAA; serials 10639 - 10646, 10660 - 10666 of 174A-OC-56120-1A; serials 2125-2127 of 174A-OC-56120-G; serial 487 of 174A-OC-56120-Y; serials 484-487 of 174A-OC-56120-Z represent the first interim release of information responsive to your Freedom of Information Act (FOIA) request.

To minimize costs to both you and the FBI, duplicate copies of the same document were not processed.

The FBI acknowledges your agreement to pay the balance of \$808.00 in search fees when documents/records are released to you on CD-ROM's at a cost of \$15.00 each. The enclosed CD-ROM is the first interim release of information responsive to your FOIA request. Upon receipt of the enclosed CD-ROM, please make a check or money order payable to the Federal Bureau of Investigation in the amount of \$823.00 and remit payment to the Work Process Unit, Record Information/Dissemination Section, Records Management Division, Federal Bureau of Investigation, 170 Marcel Drive, Winchester, VA 22602. Please include the FOIPA request number(s) with your payment. If we do not receive this payment within thirty (30) days from the date of this letter, your request will be closed administratively. Nonpayment will also cause an automatic denial of any future FOIPA requests.

EXPLANATION OF EXEMPTIONS

SUBSECTIONS OF TITLE 5, UNITED STATES CODE, SECTION 552

- (b)(1) (A) specifically authorized under criteria established by an Executive order to be kept secret in the interest of national defense or foreign policy and (B) are in fact properly classified to such Executive order;
- (b)(2) related solely to the internal personnel rules and practices of an agency;
- (b)(3) specifically exempted from disclosure by statute (other than section 552b of this title), provided that such statute(A) requires that the matters be withheld from the public in such a manner as to leave no discretion on issue, or (B) establishes particular criteria for withholding or refers to particular types of matters to be withheld;
- (b)(4) trade secrets and commercial or financial information obtained from a person and privileged or confidential;
- (b)(5) inter-agency or intra-agency memorandums or letters which would not be available by law to a party other than an agency in litigation with the agency;
- (b)(6) personnel and medical files and similar files the disclosure of which would constitute a clearly unwarranted invasion of personal privacy;
- (b)(7) records or information compiled for law enforcement purposes, but only to the extent that the production of such law enforcement records or information (A) could be reasonably be expected to interfere with enforcement proceedings, (B) would deprive a person of a right to a fair trial or an impartial adjudication, (C) could be reasonably expected to constitute an unwarranted invasion of personal privacy, (D) could reasonably be expected to disclose the identity of confidential source, including a State, local, or foreign agency or authority or any private institution which furnished information on a confidential basis, and, in the case of record or information compiled by a criminal law enforcement authority in the course of a criminal investigation, or by an agency conducting a lawful national security intelligence investigation, information furnished by a confidential source, (E) would disclose techniques and procedures for law enforcement investigations or prosecutions, or would disclose guidelines for law enforcement investigations or prosecutions if such disclosure could reasonably be expected to risk circumvention of the law, or (F) could reasonably be expected to endanger the life or physical safety of any individual;
- (b)(8) contained in or related to examination, operating, or condition reports prepared by, on behalf of, or for the use of an agency responsible for the regulation or supervision of financial institutions; or
- (b)(9) geological and geophysical information and data, including maps, concerning wells.

SUBSECTIONS OF TITLE 5, UNITED STATES CODE, SECTION 552a

- (d)(5) information compiled in reasonable anticipation of a civil action proceeding;
- (i)(2) material reporting investigative efforts pertaining to the enforcement of criminal law including efforts to prevent, control, or reduce crime or apprehend criminals;
- (k)(1) information which is currently and properly classified pursuant to an Executive order in the interest of the national defense or foreign policy, for example, information involving intelligence sources or methods;
- (k)(2) investigatory material compiled for law enforcement purposes, other than criminal, which did not result in loss of a right, benefit or privilege under Federal programs, or which would identify a source who furnished information pursuant to a promise that his/her identity would be held in confidence;
- (k)(3) material maintained in connection with providing protective services to the President of the United States or any other individual pursuant to the authority of Title 18, United States Code, Section 3056;
- (k)(4) required by statute to be maintained and used solely as statistical records;
- (k)(5) investigatory material compiled solely for the purpose of determining suitability, eligibility, or qualifications for Federal civilian employment or for access to classified information, the disclosure of which would reveal the identity of the person who furnished information pursuant to a promise that his/her identity would be held in confidence;
- (k)(6) testing or examination material used to determine individual qualifications for appointment or promotion in Federal Government service the release of which would compromise the testing or examination process;
- (k)(7) material used to determine potential for promotion in the armed services, the disclosure of which would reveal the identity of the person who furnished the material pursuant to a promise that his/her identity would be held in confidence.

FEDERAL BUREAU OF INVESTIGATION

Precedence: PRIORITY

Date: 05/16/2005

To: Counterterrorism

Attn: DTOU

Denver

Attn: A/SSA [redacted]
SSA [redacted]
SSA [redacted]
SA [redacted]

Detroit

Attn: SSSRA [redacted]
SA [redacted]
Flight RA [redacted]
SSA [redacted]
Bay City RA [redacted]
SSRA [redacted]
Oakland RA [redacted]
SRA [redacted]
Marquette RA [redacted]

Jacksonville
Little Rock
Oklahoma City

Attn: SA [redacted]
Attn: JTTF Supervisor
Attn: JTTF Supervisor

685

From: Kansas City
Squad 8 / Wichita Resident Agency
Contact: SA [redacted]

b2
b6
b7C

Approved By: [redacted]

Drafted By: [redacted]

ebs ^{EGS}

Case ID #: 266A-DE-97705 (Pending) - 229
174A-OC-56120 (Pending) - 11117
266A-DN-64168 (Pending) - 261

Title: [redacted]

AOT - VC

OKBOMB;
MAJOR CASE 117

TERRY LYNN NICHOLS;
CORRECTIONAL INTELLIGENCE INITIATIVE;
AOT - DT

Synopsis: To provide information regarding the search of Terry Nichols' former home in Herington, Kansas and to inform receiving offices of Kansas City's subsequent investigation. This communication also serves to transmit FD-302's and investigative notes regarding the aforementioned investigation.

A:\TNSearch.ec

4

174A-OC-56120-11117

To: Counterterrorism From: Kansas City
Re: 266A-DE-97705, 05/16/2005

Administrative: Original copies of all documents associated with this communication are being forwarded to Oklahoma City for incorporation into case file 174A-OC-56120.

Enclosure(s): Enclosed for Oklahoma City are the originals and copies of nine (9) FD-302's and the original investigative notes and photographs contained in nine (9) attached FD-340 (1A) envelopes. Also enclosed for Oklahoma City are photographs depicting the search of Nichols' former home in Herington, Kansas. Finally, enclosed for all offices are aerial views of the search location where a .50 caliber rifle was recovered.

Details: On 03/25/2005, Kansas City Division, Wichita Resident Agency, received a Priority Lead from Jacksonville Division wherein a source of that office provided information regarding the location of explosives and other items related to "an impending act of domestic terrorism." These items were described as being located at 109 S. Second Avenue, Herington, Kansas, the former home of convicted Oklahoma City Bombing co-conspirator, Terry Lynn Nichols.

b6
b7C
b7D

On 03/31/2005, SA [redacted] conducted a morning briefing with members of the Wichita Joint Terrorism Task Force regarding the lead set forth by Jacksonville, and the investigative steps to be undertaken by the Wichita JTTF. The following time line provides an accounting of the actions taken by the Kansas City Division:

At 8:30 a.m. on 03/31/2005, the Wichita JTTF met to discuss investigative options related to the [redacted]. SA [redacted] tasked SA [redacted] and Task Force Officer (TFO) [redacted] to locate the current owner of the Herington, Kansas property, thought to be [redacted] who resides in [redacted] Kansas.

At 12:00 p.m. on same date, SA [redacted] and TFO [redacted] arrived in [redacted], Kansas, but were unable to locate [redacted]. Further attempts to locate [redacted] were unsuccessful and agents departed [redacted] at approximately 2:30 p.m. The [redacted], Kansas Police Department assisted agents in locating [redacted], but again met with negative results. SA [redacted] and TFO [redacted] departed [redacted] for Herington, Kansas, but left a note for [redacted] to call in case he returned.

b6
b7C

At approximately 3:00 p.m., SA [redacted] and TFO [redacted] arrived in Herington, Kansas and upon locating the house, found it was for sale by [redacted] Real Estate, " [redacted] [redacted] was contacted using the number listed on the sale

To: Counterterrorism From: Kansas City
Re: 266A-DE-97705, 05/16/2005

sign and [] agreed to meet. Soon afterwards, [] signed a consent to search form and agents entered the home at approximately 3:30 p.m.

Using the information provided by the Jacksonville Division, agents began a diligent search of the home taking photographs of locations where the explosives were allegedly left by Nichols. At approximately 4:30 p.m., SA [] and TFO [] advised they had searched in the locations detailed by Jacksonville, but could not locate any explosives or their precursors.

SA [] advised [] and [] he would contact SA [] in Jacksonville in the chance he could obtain more specific information from his source that would assist the search. SA [] was able to contact his source and did provide additional information which was passed on to SA [] and TFO [] who, within minutes of receiving this additional information, located a cache of unknown items appearing to match the description of those detailed by the source information.

b6
b7c

TFO [] and SA [] carefully removed the outer coverings which obscured the items within, took several photographs with a digital camera, and pulled back to notify Wichita of their discovery.

Between 5:30 p.m. and 6:00 p.m., SSRA [] of the Wichita RA notified SAC Kevin Stafford of the discovery and then requested the FBI Bomb Technicians deploy to assist. SSRA [] and SA [] departed Wichita for Herington at approximately 6:00 p.m.

From 6:00 p.m. to 6:30 p.m., SA [] and TFO [] contacted the Herington Police Department who began to organize an evacuation of the houses near Nichols' former home. SSRA [] and SA [] arrived in Herington, Kansas at approximately 7:15 p.m. At the same time, the Bomb Technicians of FBI KC and representatives from the Topeka, Kansas Police Department Bomb Squad were en route.

b6
b7c

For the next two hours, briefings were conducted and preparations were made for the arrival of the bomb technicians. The Herington Fire Department provided excellent volunteer support blocking off roads for several square blocks and setting up floodlights. The Topeka Bomb Squad and FBI Kansas City Bomb Technicians arrived at approximately 9:20 p.m. and conducted a walk through of the home.

From 10:10 p.m. on March 31, 2005, to 5:00 a.m. on April 1, 2005, SA's [] and [] of the FBI, and

To: Counterterrorism From: Kansas City
Re: 266A-DE-97705, 05/16/2005

Sergeant [redacted] of the Topeka Police Department conduct multiple entries into the home removing 505 electric detonators also known as "blasting caps." Also removed and X-Rayed, were packages of "Kinestik" liquid containers. Additional items were left undisturbed in the crawlspace until the search team could rest. Those items which were removed were placed back into the home and guarded overnight by SSRA [redacted] and SA [redacted]

Between 7:30 a.m. and 8:00 a.m. on April 1, 2005, TFO's [redacted] and [redacted] arrived on scene and SA [redacted] provided a morning update to SA [redacted] acting SSA at the Domestic Terrorism Operations Unit (DTOU) at FBI HQ.

At approximately 9:30 a.m. members of the Kansas City Evidence Response Team (ERT) and SA [redacted], the Kansas City Division Public Relation's Agent arrived and received briefings from SSRA [redacted] and SA [redacted]

b6
b7c

Between 10:00 a.m. and 10:30 a.m., the bomb technicians arrived as ERT began photographing the outside of the residence. SAC Kevin Stafford and Chief Division Counsel (CDC) [redacted] also arrived on scene. Concurrently, photographs taken the day previous by SA [redacted] and TFO [redacted] are sent to DTOU by SA [redacted] [redacted] in Wichita, Kansas.

At 11:00 a.m., SA [redacted] and SGT [redacted] reentered the residence and discovered a military style ammunition can with unknown contents. Various attempts to safely remove the ammunition can were made and finally, at approximately 1:45 p.m., the can was opened with the assistance of an ordinance handling/removal robot. The can contained booklets, additional non-electric blasting caps, and a hotel comment card signed by Terry Nichols.

Once the crawlspace and adjacent locations were deemed safe by the bomb technicians, ERT entered the home and began a thorough search. From 2:00 p.m. until approximately 5:00 p.m., ERT dug through the basement crawlspace, searched through available spaces above the drop ceiling tiles, and logged all items recovered by the bomb technicians. Items were then removed from the home and taken to the Kansas City Division for further evidentiary processing.

b6
b7c

Once all items were removed from the home, [redacted] was escorted through the property and briefed by CDC [redacted] and ERT Team Member SA [redacted] about the search. [redacted] was advised only total deconstruction of the home could guarantee that all hazardous items had been removed, but barring that possibility, all possible locations had been searched. [redacted]

To: Counterterrorism From: Kansas City
Re: 266A-DE-97705, 05/16/2005

said she understood and signed the FD-597 listing the items which had been removed. A copy of the FD-597 was provided to [redacted]

At approximately 6:00 p.m., all parties departed Herington, Kansas and the Herington Police reopened the block for traffic and inhabitants.

The Wichita Resident Agency conducted an additional search related to items hidden by Terry Nichols: At approximately 11:15 a.m. on April 28, 2005, SA [redacted] received a call from SA [redacted] of the Colorado Springs RA regarding information he had obtained from a recent interview with Oklahoma City Bombing Co-conspirator, Terry Nichols. During this interview, SA [redacted] asked Nichols if he had hidden any other explosives or dangerous items aside from what had already been located at his former residence in Herington, Kansas. Nichols advised he had hidden or "stored" a .50 caliber rifle in an illegal dumping area near a riverbank approximately two miles north of Herington, Kansas. Nichols said he placed the weapon there on April 20, 1995.

b6
b7c

SA [redacted] also explained that Nichols had found a fragmentation grenade owned by McVeigh and placed it in an ammunition can after which he either a) "buried" it next to the .50 Caliber, or b) threw it in the river. Nichols further advised that en route to the .50 caliber's burial location, he had jettisoned McVeigh's Arizona license plate into a river crossed by a blacktop road leading north from Herington, KS.

SA [redacted] and TFO [redacted] used a rough sketch and additional written information provided by SA [redacted] to conduct a map reconnaissance of the area. Multiple locations fit the description Nichols provided of his burial location, but one location in particular became an immediate focus of the search based on proximity and relationship to the written instructions. The written information provided by SA [redacted] was as follows:

b6
b7c

["A .50 caliber rifle was hidden on the side of the road approximately two miles north of Herington, KS [sic]. The rifle was buried on April 20, 1995 and had been stolen from the residence of [redacted]. Directions are as follows:

Go north out of Herington [sic] on a black top road which parallels Highway 77. Continue on the road past Highway 4 and over a river. Past the river approximately ½ mile, go east on a gravel road which is straight except for a bend which parallels a river. The river bend will be on the north side of the gravel road. The rifle was placed under a mattress/box spring half way down the river bank, approximately 15 or 20 feet from the river.

To: Counterterrorism From: Kansas City
Re: 266A-DE-97705, 05/16/2005

The area where the rifle is stored may have been used as an illegal dumping ground for the local residents.

An anti-personnel hand grenade was either placed in an [sic] green ammunition can and left with the rifle or thrown into the river, below the stored rifle.

The river that is crossed while driving north out of Herrington [sic] contains the license plate of Tim McVeigh's vehicle. It was thrown into the river on April 20, 1995."

SA [] and TFO [] arrived at the probable search location at approximately 2:30 p.m. on April 28. Three possible locations along the riverbank were noted for search - the first being the one most likely to contain the buried weapons. A bed box spring was located on a steep embankment approximately twenty feet from the surface of the water. The incline on the bank was approximately 45 degrees or better requiring the use of a pulley (come-a-long) to remove the embedded box spring. Once removed, the soil underneath was loose, but a search revealed negative results. b6 b7c

From this location, the search progressed east along the steep embankment which was clearly an area where trash had been dumped for years. Much of the trash consisted of bottles, bailing wire, and fencing material which took time to remove and search. Another box spring was located east of the first location, but this was likely the internal spring of a pickup truck bench seat. This was removed and an additional search took place. Again, with negative results.

Continuing east along the embankment, TFO [] stated he had located what he thought was the case of a long rifle and upon exhumation it became obvious it was, indeed, the .50 caliber rifle. The rifle was contained in a flexible, but damaged black rifle case, wrapped in thin transparent plastic, also in poor condition. The plastic wrapping was similar to that which was used in the storage of the blasting caps and "Kinepac" discovered in Nichols' former residence. The rifle was located at approximately 4:45 p.m. Also, located around the weapon were various pieces of garbage with date stamps: A "Ziploc" bag and a bottle of homemade "hot sauce" were dated 1996. Given the layers of trash and sediment deposited there, it correlates with the date Nichols dumped the rifle.

Agents conducted an additional search of the area surrounding the .50 Caliber rifle, but met with negative results. If the grenade was stored in a sealed ammunition can, it may have floated downstream during the multiple times the area was

To: Counterterrorism From: Kansas City
Re: 266A-DE-97705, 05/16/2005

underwater due to localized flooding. The meander on which the weapon was buried, may contain the ammunition can, but it will require additional equipment for a thorough search. It is also probable the ammunition can (which are not inherently waterproof), if submerged, is full of water and has negated the explosive properties of the grenade.

The road leading north from Herington is named State Route 218/Union Road and crosses the stream where Nichols said he threw out McVeigh's license plate. Time constraints and improper clothing prohibited a search of this area. Ten years of sedimentation will be problematic if such a search for the plate is required.

SA [redacted] and TFO [redacted] took 35mm photographs of the search area and rifle and departed the scene shortly after 6:00 p.m. An overhead view of the search location is attached for review. The center of the image shows a meander causing a curve in the "unnamed street" which is actually 1000 Ave. The actual search location on this meander would be at the 5 - 6 o'clock position of the curve. The north/south hardball road just to the east of this location is Union Road/St Route 218 and where this road intersects the stream is the location where Nichols said he threw the license plate.

b6
b7c

Kansas City considers all leads associated with the requested searches to be covered.

To: Counterterrorism From: Kansas City
Re: 266A-DE-97705, 05/16/2005

LEAD(s):

Set Lead 1: (Info)

COUNTERTERRORISM

AT DTOU

Read and clear.

Set Lead 2: (Info)

DENVER

AT DENVER, COLORADO

Read and clear.

Set Lead 3: (Info)

DETROIT

AT FLINT, MICHIGAN

Read and clear.

Set Lead 4: (Info)

JACKSONVILLE

AT JACKSONVILLE, FLORIDA

Read and clear.

Set Lead 5: (Info)

LITTLE ROCK

AT LITTLE ROCK, ARKANSAS

Read and clear.

To: Counterterrorism From: Kansas City
Re: 266A-DE-97705, 05/16/2005

Set Lead 6: (Info)

OKLAHOMA CITY

AT OKLAHOMA CITY, OKLAHOMA

For information and incorporation into the relevant
case files.

◆◆

FD-340 (Rev. 4-11-03)

File Number 174-0C-56120 OKBcmR 1A10639

Field Office Acquiring Evidence _____

Serial # of Originating Document 11074

Date Received 3-14-05

From NY-33387-IA
(Name of Contributor/Interviewee)

(Address)

(City and State)

By TFO / SA b6
b7C

To Be Returned Yes No

Receipt Given Yes No

Grand Jury Material - Disseminate Only Pursuant to Rule 6 (e)
Federal Rules of Criminal Procedure

Yes No

Federal Taxpayer Information (FTI)

Yes No

Title:

Reference: _____
(Communication Enclosing Material)

Description: Original notes re interview of b6
b7C
b7D

① debrief notes
② letter from

① 1945 3-11-05

(AGG) [redacted] (LW) WORKING w/ [redacted]
OUT IN COLORADO NEAR ADMAX (PRISON)
TALKING TO [redacted]

b6
b7C
b7D

19 APRIL - ANNIVERSARY OF WACO.

[redacted] WORKING NICHOLS

FOR [redacted] TERRY
NICHOLS TOLD THEM A 2ND LOAD OF DEMO
FOLLOWING MURRAH BOMBING. (NEVER BEEN
USED, CACHED) [redacted]

[redacted] SAW HIM ON TV. INTERVIEW OF [redacted]
WENT WELL. [redacted] HAD CONFIDENCE [redacted]

[redacted] TOLD ABOUT CACHE. [redacted]
NICHOLS TOLD [redacted] THERE WAS A 3RD

b6
b7C
b7D

CO-CONSPIRATOR [redacted] NICHOLS BELIEVED
THAT [redacted] WAS FBI SOURCE. [redacted]
SUPPLIED McVEIGH + NICHOLS w/ DEMO TO MAKE
MURRAH BLDG STRIKE + 2ND BLDG STRIKE.

NICHOLS TOLD [redacted] HE THINKS [redacted]
WAS FBI INFORMANT. NICHOLS BELIEVES
BOTH HE + McVEIGH BEFORE MURRAH BLDG.
HIT. [redacted] + 1ST HIT WAS DONE
PRIOR TO ARREST.

b6
b7C
b7D

Nichols Says As [redacted] PROVIDED
[redacted] Explosives to 1st + 2nd Jobs (NOT TAKEN
PLACE YET):

Nichols BELIEVES WAS AN FBI STING,
GONE WRONG. BELIEVES [redacted] GOT EXPLO.
THRU FBI, I.E. - FBI COMMITTED BOMBING

[redacted] IS

ONLY MAN THEY CAN TRUST.
2ND LOAD LOCATION -

[redacted] SAYING HE

~~KNOWS~~ KNOWS WHERE EXPLOSIVE IS

[redacted] HAS ANOTHER CON THOUGH

b6
b7C
b7D

[redacted]

[redacted]

[redacted] CALLED [redacted] CALLED

[redacted]

3

CALLER HAD ADD. OF LOAD OF DEMO.
FBI SEARCHED HOME IN PAST

ADD: 109 SOUTH 2ND ~~STREET~~ AVENUE
HERINGTON, KANSAS

b6
b7C
b7D

LOAD IS INSIDE HOME, NOT OUT.

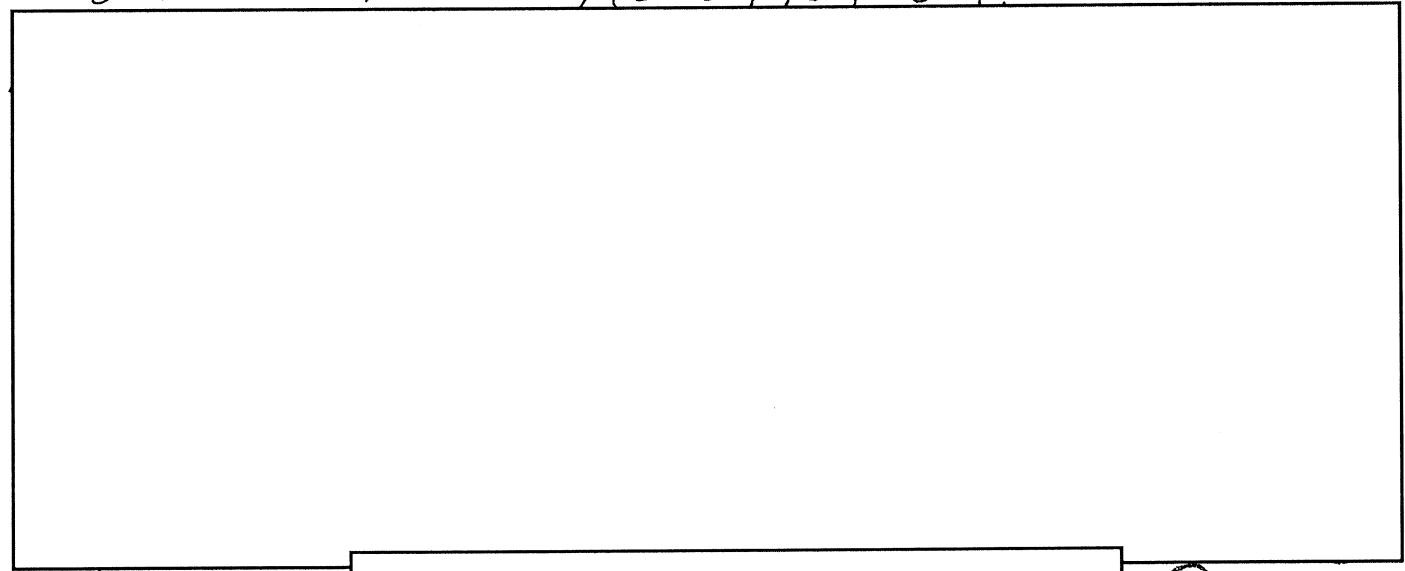

ADD WAS

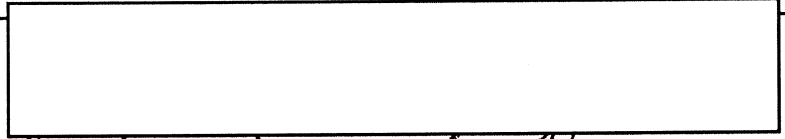

@ / TIME,

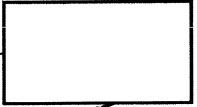

TESTIFIED AGAINST NICHOLS IN HIS

TRIAL.

b6
b7C
b7D

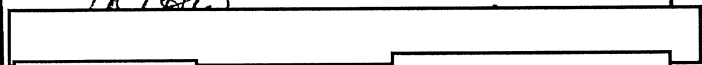

WANT



PRINTS OFF INSIDE

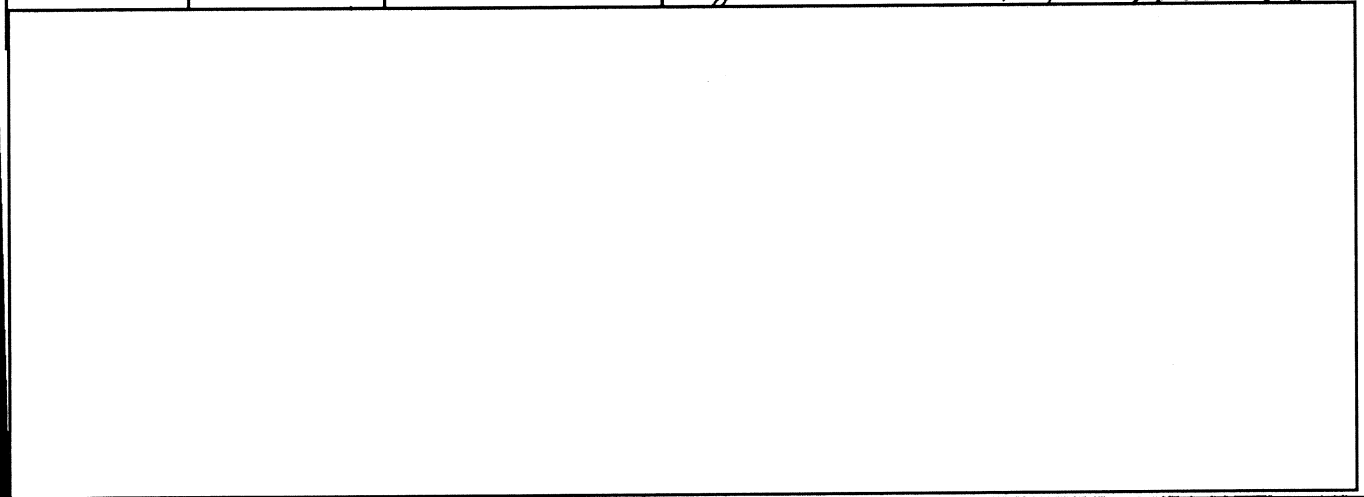

NICHOLS SAYS (A)

KERRY SAYS
CARRIED IT.

HAS

b6
b7C
b7D

THERE) CAN'T

RECALL IF CAN

(K)

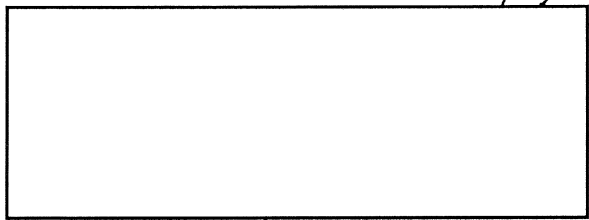

WANTS US TO CHECK

PRINTS ON ENTIRETY OF BOX.

b6
b7C
b7D

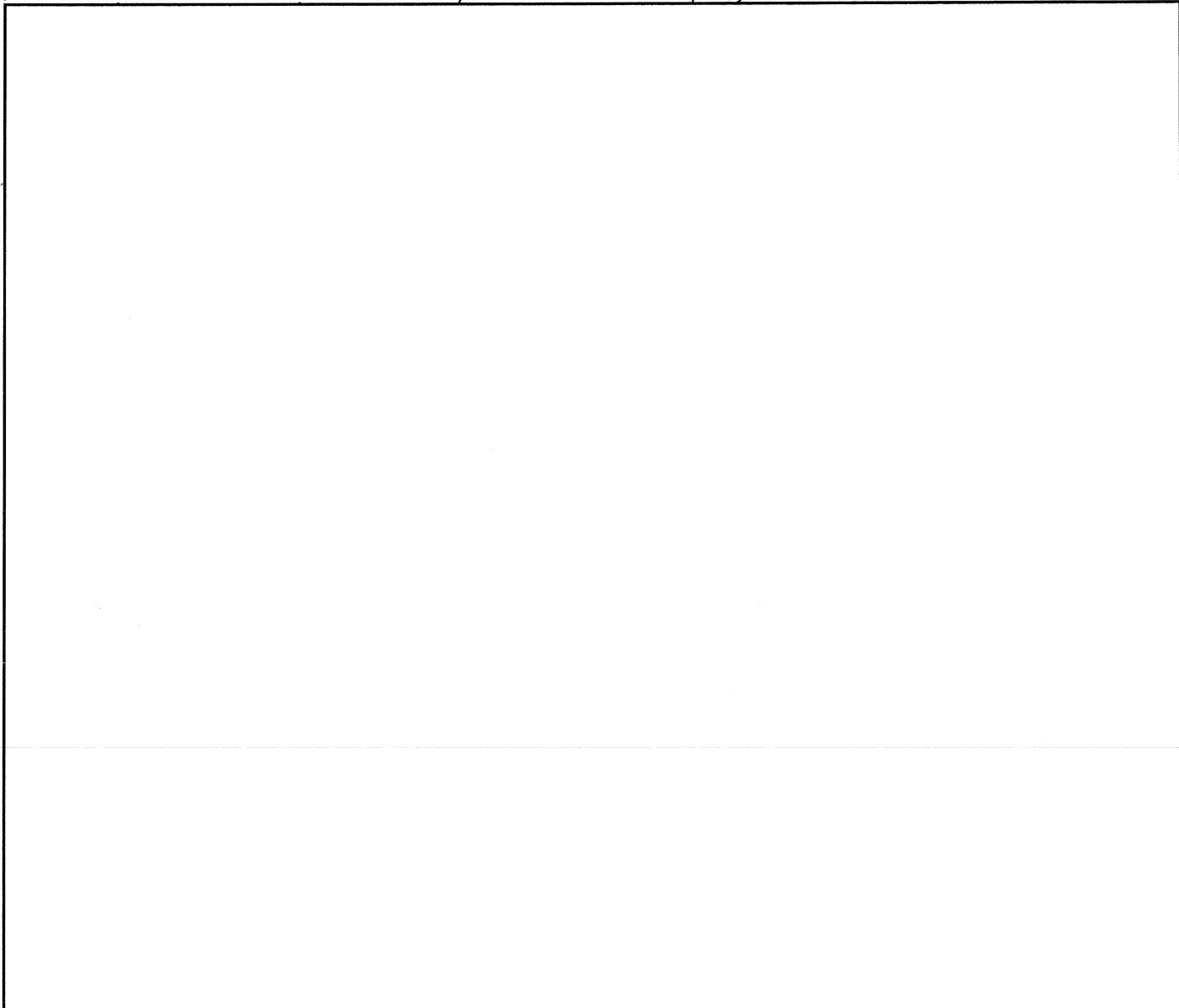

[Redacted]

Tuesday, March 1, 2005

[Redacted]

Office of Congressman William Deiahunt
Washington, D.C.

b2
b6
b7C
b7D

Re:

[Redacted]
Report of Imminent Act of Domestic Terrorism

Dear [Redacted]

This morning I received a call from [Redacted] who informed me that [Redacted] "the location of a bomb on U.S. soil" (approximate quotation), that he had asked [Redacted] to arrange for him to provide this information to an appropriate agency (FBI or BATF) but that no action appeared to have been taken and that the threat was imminent.

Because of prior efforts [Redacted]

[Redacted] intelligence which I am confident was fully credible,¹ and because at least one of these officials is now in a very senior position in Washington (general counsel of the FBI), I was concerned that [Redacted] would not be dealt with in good faith by federal agents.

On the assumption that a referral from a member of Congress was more likely to elicit a good-faith response, I immediately attempted to reach [Redacted] calling your Washington office, where I left my phone number when the receptionist elected not to receive any indication of the substance of the matter concerning which I was calling.

I then called a journalist acquaintance (associated with one of the major television networks), who called a member of a joint terrorism task force in California with whom he had had prior contact.

Late this afternoon [Redacted] was able to call [Redacted] to whom he gave somewhat more information:

b2
b6
b7C
b7D

- He has been in contact with [Redacted]
- [Redacted] domestic, not foreign, terrorist.

[Redacted]

- Action by federal authorities by Thursday, March 3, 2005, is imperative or "it's over with";

¹ FBI Forms 302 recounting the intelligence [Redacted] including details of specific terrorist actions and plans, are summarized in our April 2004 submission to the "9-11 Commission," and we have documented the validity of this intelligence.

"we don't want another Oklahoma City bombing."

In light of the information provided [redacted] it appears likely that the [redacted] Terry Lynn Nichols (Florence ADMAX, Inmate Reg. No. 08157-031), convicted and serving a life term as a coconspirator with Timothy McVeigh in the Murrah Building (Oklahoma City) bombing. Nichols has [redacted] [redacted] has been identified with various "antigovernment" activities.

b2
b6
b7C
b7D

[redacted]

I would note that,

[redacted]

We will appreciate your assistance in securing an appropriate response to the information which

[redacted]

Sincerely,

[redacted signature block]

b2

FD-340 (Rev. 4-11-03)

File Number 174A-AC-56126 1A10640

Field Office Acquiring Evidence KC

Serial # of Originating Document _____

Date Received 04/01/2005

From 109 2nd St.
(Name of Contributor/Interviewee)

(Address)

Herington KS
(City and State)

By SA

To Be Returned Yes No

Receipt Given Yes No

Grand Jury Material - Disseminate Only Pursuant to Rule 6 (e)
Federal Rules of Criminal Procedure

Yes No

Federal Taxpayer Information (FTI)
 Yes No

b6
b7c

Title:

Reference: _____
(Communication Enclosing Material)

Description: Original notes re interview of
FD-597 and Logs from
Consent search of residence

ROLL# 1

DATE 4 / 1 / 05
MONTH DAY YEAR

AGENCY FBI

CASE ID OKBOMB

PHOTOGRAPHER SA

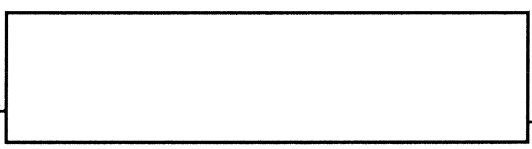

b6
b7C

LOCATION 109 EAST 2nd St.
Herington, KS

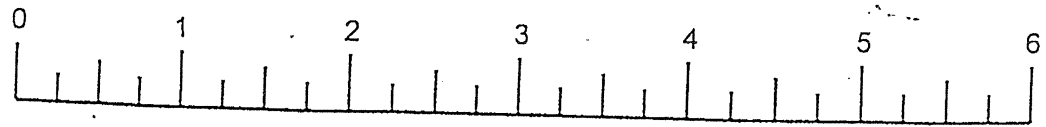

GENERAL INFORMATION	CAMERA/FILM INFORMATION
DATE <u>4/1/05</u>	CAMERA <u>Nikon</u>
CASE ID <u>OK BOMB</u>	TYPE OF FILM _____
LOCATION <u>109 2nd St. Heerington, KS</u>	RATING _____
PREPARER/ASSISTANTS <u>SA</u> 	REMARKS _____
b6 b7C <u>SSA</u>	

PHOTO#	USE OF SCALE	DESCRIPTION OF PHOTOGRAPHIC SUBJECT / MISCELLANEOUS COMMENTS
1	N/A	Cover page (Out of focus)
2	N/A	Cover page
3		Outside of residence (overall) from North
4		Outside of residence (Center)
5		Outside of residence (from South)
6		Outside of residence (from West side)
7		Outside of residence (from East side)
8		Side of residence from West
9		Interior from front door
10		Living room from inside entryway (North)
11		Living room from South corner
12		Living room from West corner
13		Front bedroom from West
14		2nd BR from West
15		2nd BR from East
16		Laundry room / BR from 2nd Bedroom
17		Kitchen from laundry room
18		Mudroom from kitchen
19		Basement stairs (from laundry room)
20		Crawl space (from basement steps)
21		2nd Crawl space (from bottom of basement steps)
22		Close up of 2nd Crawl space
23		Crawl space (from entryway)
24		Crawl space (from living room)
25		Crawl space (from living room) 10:22 am end of roll
26		
27		
28		
29		
30		
31		
32		
33		
34		
35		
36		

PHOTOGRAPHER SA

b6
b7c

DATE 4 / 1 / 05 ROLL # 2
Month Day Year

LOCATION Honghai, KS 109 2nd SA

CASE FILE Ok bomb

AGENCY FBI - KC

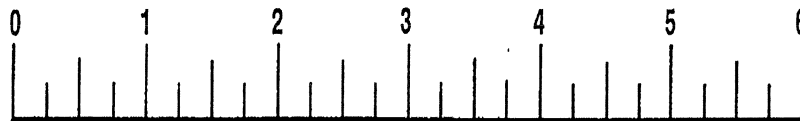

CAMERA _____

FILM : ASA _____

ROLL No. _____

LENS - Normal - N

Wide - W

Macro - M

Tele. - T

LIGHT - Available - A

Elec. Strobe - E

Flashbulb - F

Photo No.	Lens	Light	SS	f - stop	Description	Photo Log Sketch
1					Photo Log	
2					Green Metal Building	Green Metal Bldg in basalt crowd space near foundation vent, covered by rock
3					"	
4					"	
5					"	
6					"	
7					"	
8					"	
9					New electric lines	New electric lines
10					Also electric lines	
11					Print out 7 1/2 mm film w/ scale	
12					" w/ scale	
13					" w/ scale	
14					" w/ scale	
15					" w/ scale	
16					" w/ scale	
17					bedroom exit	
18					Living room exit	
19					2nd floor exit	
20					Living room exit	
21					Kitchen exit	
22					Unit 2nd floor exit	
23					Living room exit	
24					Front of house	
25						
26						
27						
28						
29						
30						
31						
32						
33						REMARKS
34						
35						
36						

FRANCE

TAG

109 2nd St. Berrydale, KS

4/1/05

9:11 AM under the type

9:15 AM Site Survey; led by

10:22 SA finished photographs

b6
b7c

10:25 SA begins sketch

10:40 Sgt and SA/SAO re-ate Basement

11:04 SA and SAC Stafford entered the crime scene

11:04 Detective entered the crime scene

1:10 entered crime scene (TPO) Search resumes following activity

2:20 TPO entered crime scene

3:40 EMT search of scene complete

4:20 CDC + SA given access

4:55 Exit Photos finished

UNITED STATES DEPARTMENT OF JUSTICE
FEDERAL BUREAU OF INVESTIGATION
Receipt for Property Received/Returned/Released/Seized

Page 1 of 1

On (date) 04/01/2005

Time: 1514 HOURS

item(s) listed below were:

- Received From
- Returned To
- Released To
- Seized

(Name) b6
 (Street Address) 109 2nd Street b7C
 (City) HERINGTON, KS

Description of Item(s):

- Item #1 - CARDBOARD Box within one plastic bag containing
- Item #2 - 1 CARDBOARD Remora's Box (Fellows) containing 208 (two hundred and eight) electric blasting caps.
- Item #3 - Eleven (11) electric blasting caps (currently in a Red Blasting Cap Box (DAY BOX) (Box property of TPD)
- Item #4 - CARDBOARD Box with Kinestik 1/2oz. containers
- Item #5 - CARDBOARD Box (sealed) - containing electric blasting caps - amount unknown
- Item #6 - CARDBOARD Box (sealed) - containing electric blasting caps - amount unknown
- Item #7 - CARDBOARD Box - containing electric blasting caps - amount unknown
- Item #8 - Black plastic bag (zipper) which originally held Items 4, 5, 6 & 7
- Item #9 - Black plastic bag containing CARDBOARD Box - Box contains an unknown amount of electric blasting caps
- Item #10 - Black plastic bag containing cardboard box which contains shock tube non-electric blasting caps - amount unknown
- Item #11 Green ammo box with booklets, flares, baby fuse and three (3) four smoke grenades and 1 separately packaged non-electric blasting cap, and 2 (two) electric matches & 1 (one) (Bitent print in plastic bag)
- Item #12 1 X-ray of ammo can (Item #11)
- Item #13 1 X-ray of box (cardboard) - END OF LIST

A THOROUGH SEARCH WAS CONDUCTED BY THE FBI IN ALL AREAS VISUALLY AND REACHLY ACCESSIBLE, THIS SEARCH DID NOT INCLUDE THE PHYSICAL OPERATION OR DESTRUCTION OF ANY WEAPON OR THE SEARCH AS NO PROBABLE CAUSE OR INFORMATION EXISTED TO LEAD ONE TO BELIEVE TO FIND ANY ADDITIONAL WEAPONS OR LAW ENFORCEMENT

b6
b7C

Received by:

Received from:

FD-340 (Rev. 4-11-03)

1A10641

File Number 174A-06-56120

Field Office Acquiring Evidence KC

Serial # of Originating Document _____

Date Received 04/04/2005

From ~~109~~ 109 S. 2nd
(Name of Contributor/Interviewee)

(Address)

Herington KS

(City and State)

By

[Redacted Signature Box]

b6
b7c

To Be Returned Yes No

Receipt Given Yes No

Grand Jury Material - Disseminate Only Pursuant to Rule 6 (e)
Federal Rules of Criminal Procedure

Yes No

Federal Taxpayer Information (FTI)

Yes No

Title:

Reference: _____
(Communication Enclosing Material)

Description: Original notes re interview of

Evidence Acknowledgement and

Evidence Receipt

FBI LABORATORY
Washington, D. C.



Date 04-02-07
Time 2:45 PM

EVIDENCE ACKNOWLEDGMENT

Received from of the _____
(Name and Title)

b6
b7C

Kansas City FBI
(Department or Agency)

(Address) (Phone Number)

6 box(es), 5 bag(s), 1 ^{loose plastic bag} envelope(s), _____ vial(s), 1 object(s) ^{transferred to paint can in C-Box}
Evidence Should Be:
of sealed evidence for examination in connection with case number 174A-06-56120 Mailed Back GTBD
entitled OKBOMB: MAJOR CASE 117 Picked Up By
Contributor

This evidence will remain in the custody of the FBI Laboratory while the examinations are being conducted. Following completion of the examinations, a report containing the results of the examinations and the disposition of the evidence will be forwarded to your department. If evidence is picked up personally, your representative should identify it with the Laboratory case number(s) assigned in the FBI Laboratory report.

Explosives Unit

Director
Federal Bureau of Investigation

FD-340 (Rev. 4-11-03)

File Number

174A-DC-56120

1A 10642

Field Office Acquiring Evidence

KC

Serial # of Originating Document

Date Received

04/01/2005

From

109 S. 2nd

(Name of Contributor/Interviewee)

(Address)

Herington KS

(City and State)

b6
b7C

By

To Be Returned Yes

No

Receipt Given Yes

No

Grand Jury Material - Disseminate Only Pursuant to Rule 6 (e)
Federal Rules of Criminal Procedure

Yes

No

Federal Taxpayer Information (FTI)

Yes

No

Title:

Reference:

(Communication Enclosing Material)

Description: Original notes re interview of

Sketch of Residence

- Case No. 174-BC-56120

- SA [redacted], Sketcher

- Sketch 1

- Overall East-half of block:

b6
b7c

- Major case 117 BK80M0

- 109 S. 2nd

- Herington, KS

- 04/01/2005

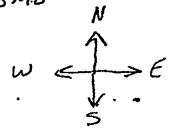

NTS

Day St.

Alley

Alley

Alley

2nd St.

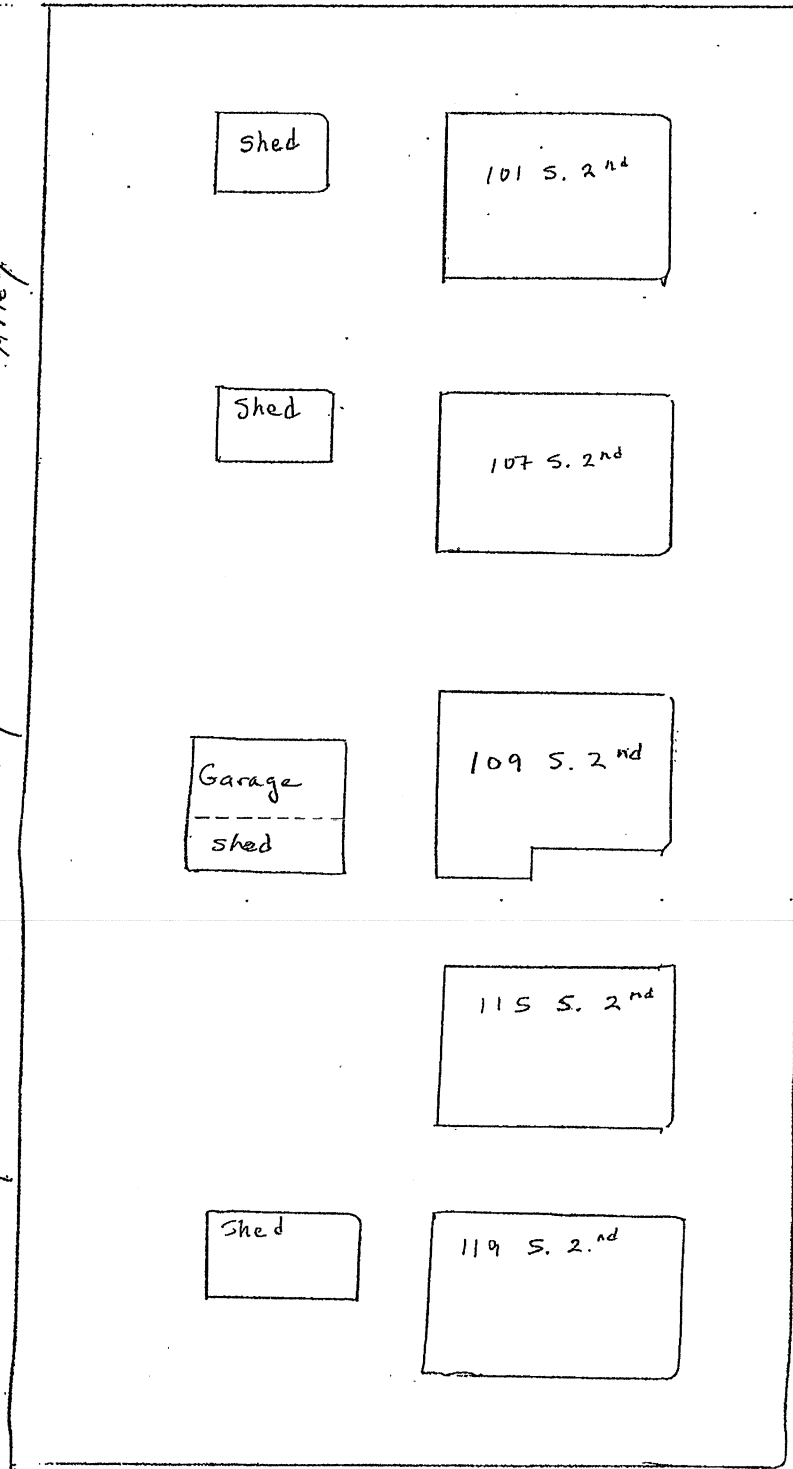

shed

101 S. 2nd

shed

107 S. 2nd

Garage
shed

109 S. 2nd

115 S. 2nd

shed

119 S. 2nd

McClaren St.

- Case No. 174 - DC - 56120 - Major Case No. 117 DK/Som B

- SA [redacted] Sketcher - 109 S. 2nd St.

- Herington, KS

- 04/01/2005

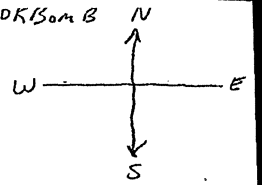

NTS

- Sketch 2

- Exterior 109 S. 2nd St.

b6
b7C

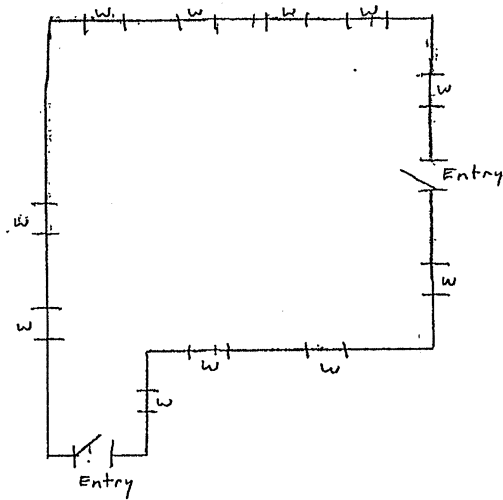
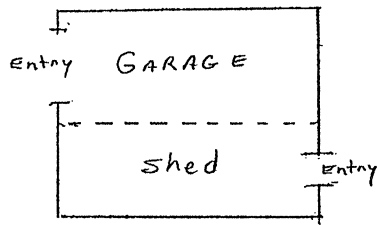

- Case No. 174 - OC - 56120

- Major Case No. 117 OK BOMB

- SA [redacted]

- 109 S. 2nd St.

- Herington, KS

- 04/01/2005

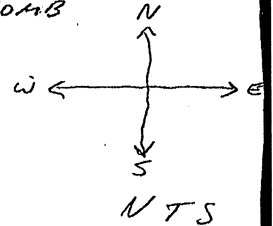

b6
b7c

- Sketch 3
- Main Floor

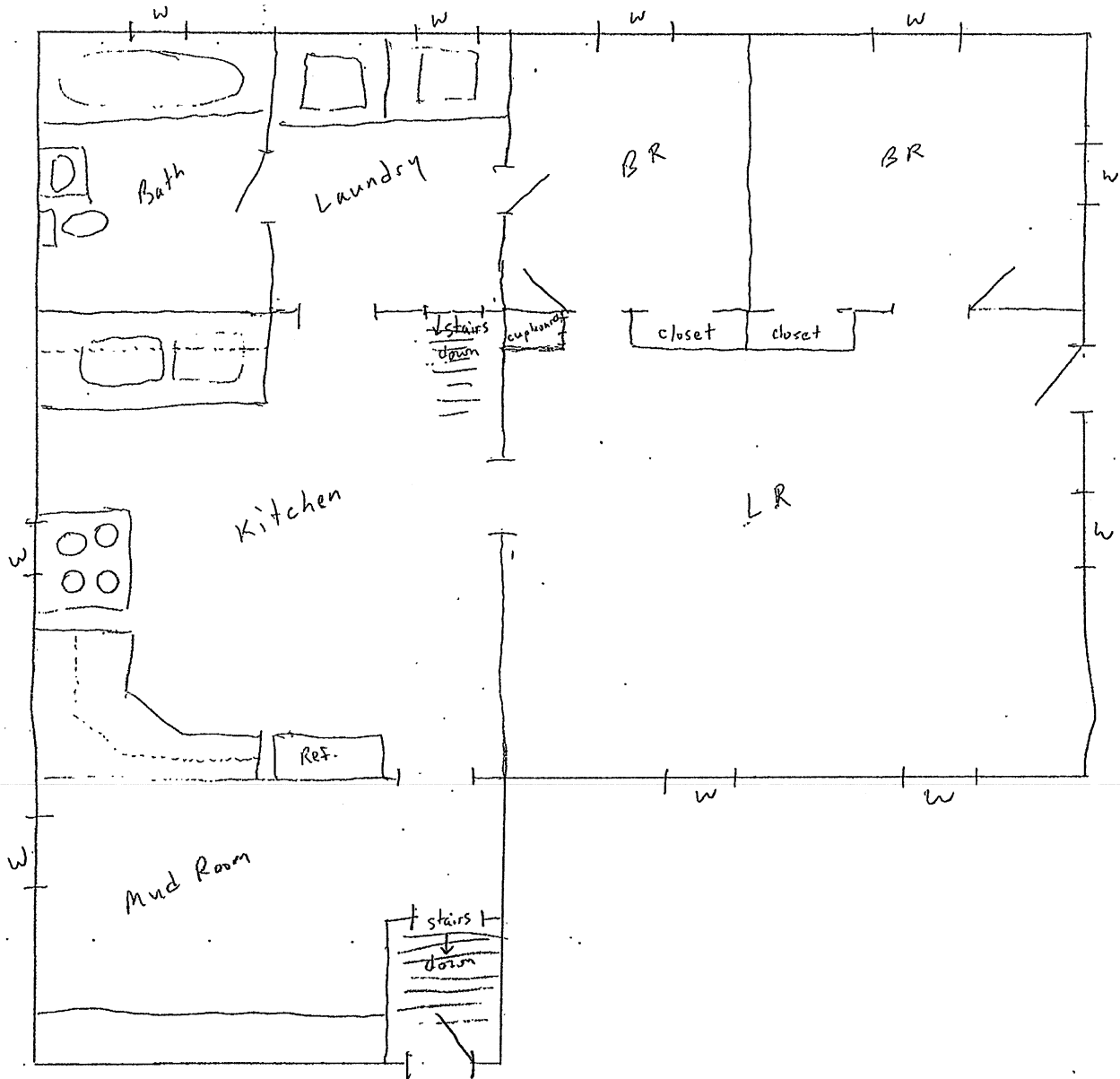

- Case No. 174-OC-56120 - Major Case No. 117 OKBOMB
- SA [redacted] - 109 S. 2nd St.
- Herington, KS
- 04/01/2005

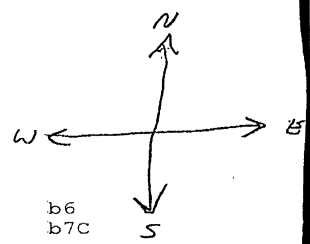

- sketch 4
- Basement and crawl space

NTS

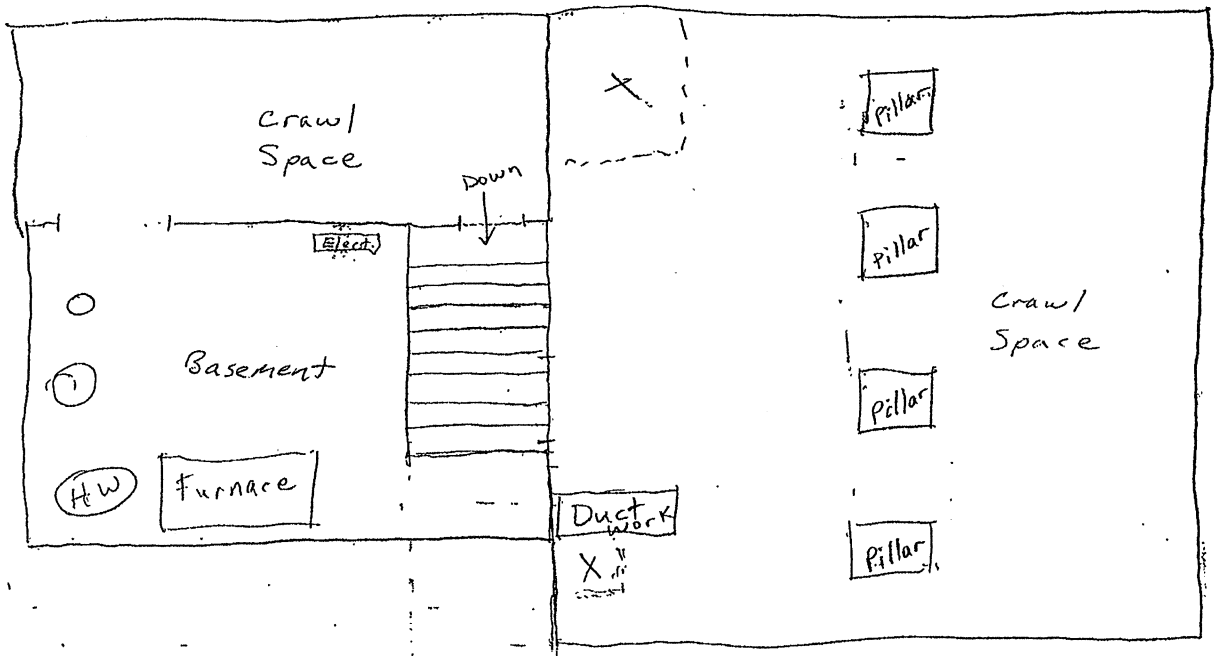

Universal Case File Number 174A-OC-56120 - 1A(10646)

Field Office Acquiring Evidence Laboratory Division

Serial # of Originating Document 11099

Date Received 05-04-07

From Omni Explosives
of Contributor)

P.O. Box 69, Marion, AR 72364 max
(Address of Contributor)

Marion, AR b6
b7C
(City and State)

By _____
(Name of Special Agent)

To Be Returned Yes No

Receipt Given Yes No

Grand Jury Material - Disseminate Only Pursuant to Rule 6 (e)

Federal Rules of Criminal Procedure

Yes No

Title:

Reference: 174A-OC-56120 Serial 11099
(Communication Enclosing Material)

Description: Original notes re interview of

Omni Explosives

FBI Laboratory Activity and Communication Log

Laboratory No.: 050402016 GA Case ID No.: 174A-OC-56120

Date	Activity/Communication and Outcome
05/02/05 By: <u>meix</u>	Emailed [redacted] a photo of Q5017 detonator to see if she can narrow the time frame of manufacture for the electric detonators.
05/04/05 By: <u>meix</u>	[redacted] From SEC called to offer further help with respect to Kinestik products.
05/04/05 By: <u>meix</u>	Spoke to [redacted] at Omni Explosives [redacted]. He will try to see if he has a record of the date/shift code on the Kinestik box to determine who it was sold to. Also told me that the black ink stamp code on the box is a UPS code.
05/04/05 By: <u>meix</u>	Spoke to [redacted] at Omni Explosives. Told me that he can't track the exact date/shift code I provided. Also, in 1989 he sold two cases of 1/2 lb nitromethane tubes and [redacted] Developers, [redacted] KS. He sold nothing to Kansas in 1990-1991. He sold one case to [redacted] Developers in 1992 and nothing else to Kansas in 1993-1995. Also told me: 1989 - 1 case (1/2 lb) to [redacted] - Wilson, AK AR 1990 - 1 case (1/2 lb) to [redacted] - Bluthe, AK AR 1991 - 1/2 case (1/2 lb) to [redacted] Construction, Conway, AK AR 1991 - 12 1/2 lb sticks to [redacted] - Pine Bluff, AK AR 1992 - No 1/2 lb cases sold 1993 - 3 cases (1/2 lb) to [redacted] Construction Company, Malvern, AK AR 1994 - No 1/2 lb cases sold 1995 - 10 1/2 lb sticks to [redacted] Fert Smith, AK AR He also informed me that it is a pretty short commute from Malvern, AR to Hot Springs, AR. Told me that all of the above sales would have been shipments and not "in person" sales.

b6
b7c

b6
b7c

meix AR

meix AR

meix

FEDERAL BUREAU OF INVESTIGATION

Precedence: ROUTINE

Date: 04/04/2005

To: Counterterrorism

Attn: DTCU

Detroit

Attn: SSRA

Denver

Attn: SSA

Kansas City

Attn: SA

Oklahoma City

Attn: JTTF Supervisor

SA [redacted]

SSRA [redacted]

Flint RA

SSRA [redacted]

Bay City RA

SSA [redacted]

JTTF Supervisor

Colorado Springs RA

b2
b6
b7C

From: Detroit

Squad CT-4/Marquette Resident Agency

Contact: SA [redacted]

Approved By: [redacted]

Drafted By: [redacted]

:llh

Case ID #: 266A-DE-97705 (Pending)
174-OC-56120 (Pending)

Title: [redacted]

11077

AOT - VC
OO: DE

OKBOMB;
MAJOR CASE 117

Synopsis: To set lead for Detroit to locate and interview [redacted]

[redacted]. Also, to advise receiving offices re results of interview with [redacted] on 04/01/2005.

b6
b7C

Enclosure(s): For Detroit's Flint RA, the original and one copy of an FD-302 re [redacted] interview. 1A containing notes of interview, facsimiles sent from [redacted] and printouts from [redacted] website. For Bay City RA, in addition to the FD-302, a copy of the news article sent from [redacted] et al. For other receiving offices, one copy of the [redacted] FD-302.

Memo: 266M-DN-64168-79

To: Counterterrorism From: Detroit
Re: 266A-DE-97705, 04/04/2005

Details: On 04/01/2005, [redacted] telephone [redacted] was contacted by Marquette RA Agents. [redacted] dba b6 b7C [redacted] agreed to be interviewed. Throughout the interview, [redacted] was cooperative but constantly derided the FBI for it's repeated failure to investigate their own misconduct, as well as, failing to followup on information he had provided to the FBI earlier regarding an explosives cache in Herington, Kansas.

It is important to preface the results of this interview with an observation concerning [redacted] and his surroundings. [redacted] drives a Chevrolet Caprice, dark in color, with a spotlight above the passenger-side, exterior rear view mirror. The vehicle looked similar to an unmarked police vehicle. The home in which [redacted] resides is a three story, early [redacted] The first and second floors appeared vacant. The third floor, an attic space, appeared to be the part of the home [redacted] resides in. [redacted] demeanor is that of a highly intelligent individual, with eccentric mannerisms.

At the beginning of the interview, [redacted] became agitated at the failure of the FBI to meet with him earlier. It was his perception, the FBI had failed to followup on critical information in the past and this incident was no different. [redacted] made no effort to hide his desire to discredit the FBI b6 b7C whenever possible.

[redacted] provided his background information, in that he had obtained a [redacted] held important positions in [redacted] organizations and knew numerous high ranking government officials. [redacted] had been [redacted] from 1985 to 1990. He stated he had uncovered a fraudulent scheme involving the university but no one would criminally pursue his allegations. Due to his unpopular relationship with the university, he was able to manipulate the situation so that he was let go from his position, and use his stance on the issue to successfully [redacted] he had the Michigan Attorney General investigate his claims. An investigation was opened and two individuals were prosecuted for a multi-million fraudulent scheme to divert university funds. b6 b7C

[redacted] provided his viewpoint on the FBI's investigative missteps regarding organized crime and in particular referred to [redacted] an SSA [redacted] FBI. He claimed to have uncovered a [redacted]

To: Counterterrorism From: Detroit
Re: 266A-DE-97705, 04/04/2005

[REDACTED]

[REDACTED] advised he was contacted by [REDACTED] to assist her on a case [REDACTED] told him she was working [REDACTED]

b6
b7C
b7D

[REDACTED] telephone call from [REDACTED] stating he had just gotten information concerning an upcoming act of domestic terrorism using explosives from a cache hidden in a home. [REDACTED] believed this matter may have been connected to TERRY NICHOLS and contacted [REDACTED] They both decided not to contact the FBI initially, since the FBI may have been involved in the Oklahoma City bombing. He therefore sent a letter to Congressman Delahunt outlining the information he had been given. Later he did send this information to the FBI.

[REDACTED] stated, he decided to go out to [REDACTED] to obtain additional information, since it appeared the FBI was not handling the matter. He stated [REDACTED]

b6
b7C
b7D

[REDACTED] This friend, when told of the [REDACTED]

They traveled to [REDACTED] met [REDACTED] and obtained detailed information of the explosive cache's whereabouts. He and his friend traveled to Herington, Kansas and surveilled the address. He claimed they did not go in the home and drove back to Michigan.

The day after interviewing [REDACTED] he sent a facsimile to SA [REDACTED] part of which contained a news article from 2004. The article contained a quote from a [REDACTED]

[REDACTED] Although no information was found in ACS regarding a [REDACTED] there were references to a [REDACTED] This name was familiar to SA [REDACTED], who had interviewed [REDACTED]

[REDACTED] He had also cited his relationship to a [REDACTED] The associated file number is, [REDACTED] [REDACTED] resided at, [REDACTED] telephone [REDACTED]

b6
b7C

[REDACTED] A search of Lexis/Nexis revealed a [REDACTED]

Although there were no references to any addresses in the Detroit

To: Counterterrorism From: Detroit
Re: 266A-DE-97705, 04/04/2005

area, he was listed as having a [redacted] as
a [redacted] which has since lapsed.

[redacted] he had a website, [redacted]
[redacted] A check of this website revealed his email
address to be; [redacted]. Contained on
his website were numerous hyperlinks to perceived criminal
conspiracies and other related matters. [redacted] was also listed
on the right-wing website, "Mackinac Center For Public Policy",
which listed his extensive curriculum vitae. It lists, in part;

[redacted]
An internet search revealed a reference to [redacted] on the website,
[redacted] An article dated 1/27/2005, consisted of an
interview of Peter Lance, a "five-time Emmy-winning investigative
reporter" and author of the bestselling 1000 Years for Revenge:
International Terrorism and the FBI -- The Untold Story. His new
book, Cover Up: What the Government is Still Hiding About the War
on Terror. His interview mentions coverups, [redacted] FBI, TWA
#800 Al Qaeda and his contact with forensic investigators.

b6
b7c

[redacted] stated, [redacted]
presented FBI 302's to the 9/11 Commission outlining the
relationship of [redacted] inferred that this
important information was ignored by the commission even though
it was significant.

After contacting [redacted] he sent facsimiles to SA [redacted]
The first facsimile sent on 04/03/2005 at 0345 hours, advising he
was the founder of the [redacted] It is
not known if [redacted] made this statement in jest or not. He did
invite the FBI to prosecute him under the 'Alien and Sedition
Acts, albeit they had expired over two centuries ago.'

b6
b7c

A review of ACS for [redacted] revealed numerous
contacts from [redacted] to the FBI since 1965, outlining perceived
criminal activities as well as references to 105 matters.

On 04/05/2005, [redacted]
called writer stating she was a Private Investigator who was
calling to ensure [redacted] information had been adequately
handled. [redacted] stated, [redacted]

[redacted]
released to the general population. She stated she held high
security clearances and was working for DOD. She also stated she
knew FBI Agents in Detroit who worked on the OC squad, although
she refused to provide any names, citing confidentiality. She
also stated she knew the SAC of Detroit's family, since she
[redacted]. She provided her address as,

b6
b7c
b7D

To: Counterterrorism From: Detroit
Re: 266A-DE-97705, 04/04/2005

[REDACTED]
and email address of, [REDACTED]. She advised she was available to assist in this matter if needed. Writer did not provide her with any information, although that appeared to be part of her goal. She added she knows about polygraphs and was able to discern if they were conducted improperly. This information is being provided since it is believed she may attempt to contact other FBI offices. A query of ACS reveals numerous complaints brought to the attention of the FBI by [REDACTED]

b6
b7c

In as much as this matter has been handled at the Marquette RA, this information is being forwarded to the Flint RA and a lead set to the Bay City RA to interview [REDACTED] in [REDACTED] Michigan. It is recommended that the Bay City RA verify with the Detroit Police Department, the employment of [REDACTED] as well as, any other pertinent information prior to his interview.

b6
b7c

To: Counterterrorism From: Detroit
Re: 266A-DE-97705, 04/04/2005

LEAD(s):

Set Lead 1: (Info)

COUNTERTERRORISM

AT WASHINGTON, DC

1. Handle as deemed appropriate.

Set Lead 2: (Info)

DENVER

AT DENVER, CO

1. Read and clear.

Set Lead 3: (Info)

DETROIT

AT FLINT, MI

1. Read and clear.

Set Lead 4: (Action)

DETROIT

AT [REDACTED] MICHIGAN

1. Locate and interview [REDACTED]

Michigan [REDACTED] regarding his association with [REDACTED] and their travels to ADMAX Florence and Herington, Kansas. In addition, obtain any information concerning any possibility that he and/or his associates entered the home in Herington, Kansas.

b6
b7c

Please coordinate with FLRA re [REDACTED] questioning..

To: Counterterrorism From: Detroit
Re: 266A-DE-97705, 04/04/2005

Set Lead 5: (Info)

KANSAS CITY

AT KANSAS CITY, MO

1. Read and clear.

Set Lead 6: (Info)

OKLAHOMA CITY

AT OKLAHOMA CITY, OK

1. Read and clear.

◆◆

FEDERAL BUREAU OF INVESTIGATION

Precedence: ROUTINE

Date: 04/11/2005

To: Laboratory

Attn: Explosives Unit
SSA [redacted]

From: Kansas City
Sq 13

Contact: SA [redacted]

Approved By: [redacted]

Drafted By: [redacted]

Case ID #: 174A-OC-56210 (Closed)

56120-11082

Title: OKBOMB;
MAJOR CASE 117;
OO:KC

b2
b6
b7c

Synopsis: To report evidence provided to the FBI Laboratory.

Details: On 03/31/2005 and 04/01/2005 a search was conducted based on consent on Terry Nichols former residence in Herington, Kansas. During the search a number of items were recovered.

On 04/02/2005, this evidence was turned over to SSA [redacted]

1 Ammunition can and lid containing a book entitles "Ragnars Homemade Detonators, a book entitled "The Poisoners Handbook ", a book entitled "Two Component High explosive mixtures and improvised shape charges," 3 handflares, hobby fuse, 3 tear smoke grenades, 2 electric matches, 1 nonelectric détonator

1 box containing 208 blasting caps

1 one cap box with 11 detonators

3 boxes of electric detonators wrapped in plastic

1 box containing nitromethane

1 box wrapped in a plastic bag, wrapped in plastic and wrapping paper containing electric blasting caps

To: Laboratory From: Kansas City
Re: 174A-OC-56210, 04/11/2005

1 box wrapped in a plastic bag containing primed blasting caps

1 opened box which contained blasting caps which wrapped in paper, wrapped in plastic and contained in a plastic bag.

The lab is being provided these items for any testing deemed necessary.

To: Laboratory From: Kansas City
Re: 174A-OC-56210, 04/11/2005

LEAD(s):

Set Lead 1: (Action)

LABORATORY

AT QUANTICO, VA

The explosives Unit is requested to do the necessary Laboratory Testing on the submitted evidence.

◆◆